

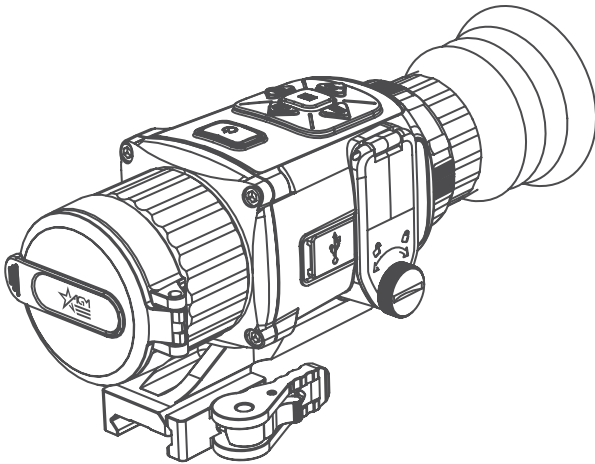

AGM
GLOBAL
VISION



RATTLER TS25-384

RATTLER TS35-384

THERMAL IMAGING RIFLESCOPE

USER MANUAL

© 2021 AGM Global Vision, LLC. All rights reserved.

This documentation is subject to change without notice.

No parts of this manual, in whole or in part, may be copied, photocopied, translated, or transmitted by any electronic medium or in machine-readable form without the prior written permission of AGM Global Vision, LLC.

Approved for public release, distribution unlimited.

If you have questions that are not covered in this manual, or need service, contact AGM Global Vision customer support for additional information prior to returning a product.

AGM Global Vision, LLC

173 West Main Street

PO Box 962

Springerville, AZ 85938

Tel. 928.333.4300

support@agmglobalvision.com

www.agmglobalvision.com

EXPORT INFORMATION

Buyer acknowledges that all products supplied by AGM Global Vision, LLC are subject to U.S. export control laws, including, but not limited to, the Export Administration Regulations, the International Economic Emergency Powers Act, and various U.S. embargoes and sanctions. AGM Global Vision products may not be exported, re-exported, or transferred contrary to U.S. export control laws. In particular, AGM Global Vision products may not be exported, re-exported, or transferred to prohibited countries, individuals, organizations, or entities, including but not limited to those individuals and entities listed on the List of Specially Designated Nationals and Blocked Persons administered or maintained by the U.S. Office of Foreign Assets Control ("OFAC"), the various lists maintained by the Bureau of Industry and Security of the Department of Commerce, and the U.S. State Department and Buyer represents and warrants that neither Buyer nor any of its officers, directors, or employees are on such lists. Distribution or resale by Buyer to such countries, individuals, organizations, or entities is expressly prohibited. Buyer has and will maintain a positive process to ensure compliance with this Section.

FCC INFORMATION

Please take attention that changes or modification not expressly approved by the party responsible for compliance could void the user's authority to operate the equipment.



This equipment complies with FCC/IC RSS-102 radiation exposure limits set forth for an uncontrolled environment. This equipment should be installed and operated with minimum distance 20 cm between the radiator & your body.

FCC compliance: This product has been tested and found to comply with the limits for a Class B digital device, pursuant to Part 15 of the FCC Rules. These limits are designed to provide reasonable protection against harmful interference in a residential installation. This product generates, uses, and can radiate radio frequency energy and, if not installed and used in accordance with the instructions, may cause harmful interference to radio communications. However, there is no guarantee that interference will not occur in a particular installation. If this product does cause harmful interference to radio or television reception, which can be determined by turning the equipment off and on, the user is encouraged to try to correct the interference by one or more of the following measures:

- Reorient or relocate the receiving antenna.
- Increase the separation between the equipment and receiver.
- Connect the equipment into an outlet on a circuit different from that to which the receiver is connected.
- Consult the dealer or an experienced radio/TV technician for help.

FCC Conditions

This device complies with part 15 of the FCC Rules. Operation is subject to the following two conditions:

1. This device may not cause harmful interference.
2. This device must accept any interference received, including interference that may cause undesired operation.

EU CONFORMITY STATEMENT



This product and - if applicable - the supplied accessories too are marked with "CE" and comply therefore with the applicable harmonized European standards listed under the EMC Directive 2014/30/EU, the RoHS Directive 2011/65/EU



2012/19/EU (WEEE directive): Products marked with this symbol cannot be disposed of as unsorted municipal waste in the European Union. For proper recycling, return this product to your local supplier upon the purchase of equivalent new equipment, or dispose of it at designated collection points. For more information see: www.recyclethis.info



2006/66/EC (battery directive): This product contains a battery that cannot be disposed of as unsorted municipal waste in the European Union. See the product documentation for specific battery information. The battery is marked with this symbol, which may include lettering to indicate cadmium (Cd), lead (Pb), or mercury (Hg). For proper recycling, return the battery to your supplier or to a designated collection point. For more information see: www.recyclethis.info

INDUSTRY CANADA ICES-003 COMPLIANCE

This device meets the CAN ICES-3 (B)/NMB-3(B) standards requirements.

LIST OF CONTENTS

TITLE	PAGE
Safety Summary	5
1. GENERAL INFORMATION	7
1.1 System Description	7
1.2 Key Features	8
2. OPERATING INSTRUCTIONS	9
2.1. Basic Operations	9
2.2 Main Function	15
2.3 Client Software Introduction	22
3. MAINTENANCE	23
3.1 Maintenance	23
3.2 Troubleshooting	24
4. WARRANTY INFORMATION	25
4.1 Warranty Information and Registration	25
5. SPECIFICATIONS	27
5.1 Specifications	27

SAFETY SUMMARY

- Read and follow all instructions
- Read all warnings
- Only use the attachments/accessories specified by the manufacturer
- All service must be provided by the manufacturer

WARNING:

This product contains natural rubber latex, which may cause potentially fatal allergic reactions! If you are allergic to latex, it is important that you strictly avoid exposure to products that contain it.

WARNING:

Always make sure your firearm is unloaded before you place the scope on the firearm. Reconfirm that the chamber is empty if you stop the procedure then resume later. Safe handling rules should be followed at all times.

WARNING:

If a scope is mounted too far to the rear, the eyepiece can injure the shooter's brow. Shooting at an uphill angle also increases this hazard because it shortens the distance between the brow and the rear of the scope. For this reason, AGM scopes are engineered to provide generous eye relief. Therefore, when mounting your scope, we recommend positioning it as far forward in the mounts as possible to take full advantage of this generous eye relief. With hard-recoiling rifles, serious injury or even death can result from eyepiece impact with the shooter during the recoil process when discharging the firearm. Be certain that your installation provides sufficient eye relief for the recoil generated by your rifle before shooting the firearm.

NOTE: Give special attention to this warning when shooting uphill and/or from a prone position. These shooting conditions can dramatically reduce eye relief. PLEASE maintain maximum eye relief when shooting heavy recoiling and/or magnum firearms. THE USER ASSUMES ALL RESPONSIBILITY AND LIABILITY FOR HAVING THE AGM RIFLESCOPE PROPERLY MOUNTED TO A FIREARM AND USING THE AGM RIFLESCOPE PROPERLY. ALWAYS CHECK THE CONDITION OF YOUR MOUNTING SYSTEM PRIOR TO USING YOUR FIREARM.

WARNING:

The proper usage of the device is important for safe exploitation! Therefore read carefully the present manual!

WARNING:

If the device was left in storage for a longer period of time, before exploitation check its functionality.

WARNING:

Disassembling of the device is prohibited, except in authorized repair centers.

WARNING:

Please remove the batteries from the battery compartment before connecting the device to your PC, or it may cause computer damage.

WARNING:

The external optical surfaces should be clean at all times. Touching the optical surfaces with bare hands is not recommended.

WARNING:

Sand and sea water can damage the optical coatings!

WARNING:

Do not point the device directly at the sun!

WARNING:

Image performance is dependent on scenery and atmosphere conditions. Contrast in the same image may vary as a function of the time of day due to the effect of the sun. For example, at sunset objects will have absorbed different levels of heat resulting in greater temperature differences and better contrast.

WARNING:

When left in storage for a longer period of time, batteries have to be removed and stored in polyethylene bags to prevent contact with metal. (It is recommended to recharge the batteries every two to three months.)

WARNING:

When carrying or transporting the device, put the protective lens cap!

WARNING:

Condensation can cause fogging of the optical surfaces! Condensation occurs when the temperature or humidity changes as follows:

- When moving the device from cold to warm place or vice versa;
- In places with high humidity.

When equalizing the temperature of the device with the environmental, the condensation disappears. Use the towel to remove moisture.

NOTES:

- The detector spectral band provides better visibility through smoke, dust, rain, smog, etc.
- Infrared radiation does not travel through glass. As a result, the riflescope does not detect objects if they are behind glass windows or other barriers.

WARNING:

Clean the lens surfaces with the lens cloth or with the napkin!

LEGAL NOTICE

Before attaching to weapons, check the regional legal regulations in the area of application. The attachment to a weapon is always the sole responsibility of the user.

1 GENERAL INFORMATION

1.1 SYSTEM DESCRIPTION

The AGM Rattler TS25-384 and Rattler TS35-384 are the compact thermal imaging scopes developed for 24 hours operation under any weather and environmental conditions. Two objective lens options allow the customer to choose perfect unit for your needs where 25 mm lens designed for short range shooting, while the 35 mm lens model will be great for medium range missions.

Thermal image rifle scope has 384×288 thermal detector and 1024×768 OLED monitor, which provides clear image under harsh environment conditions like darkness, fog, smoke, dust, rain, snow, wood, camouflage, etc. The device is used as a thermal rifle scope or handheld monocular. The scope is mainly applied to scenarios such as patrolling, and hunting, etc.

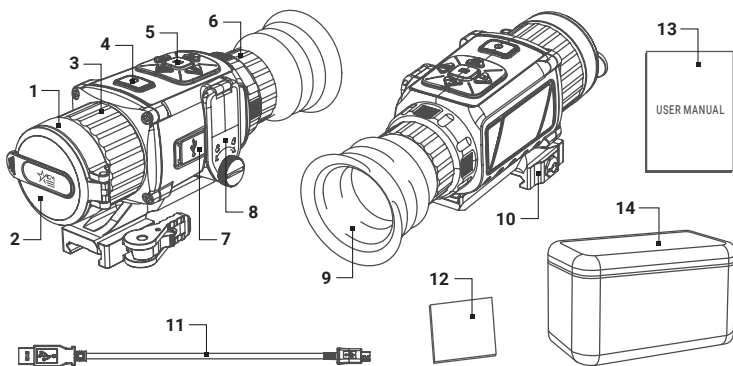

FIGURE 1-1. MAIN PARTS AND COMPONENTS

TABLE 1-1. MAIN PARTS

ITEM	DESCRIPTION
1	Objective Lens
2	Objective Lens Cover
3	Objective Focus Ring
4	Power Button
5	Operation Buttons
6	Eyepiece Focus Ring
7	USB Type-C Interface

ITEM	DESCRIPTION
8	Battery Compartment
9	Eyecup
10	Mount
11	USB Cable
12	Lens Tissue
13	User Manual
14	Carrying Bag

1.2 KEY FEATURES

- 384×288 thermal resolution, high sensitivity detector
- Image processing technology: Adaptive AGC, DDE, 3D DNR
- 1024×768 resolution 0.39-inch OLED display
- 8x digital zoom
- Lightweight and compact design
- Easy to operate control panel
- Automatic or manual (silent) calibration
- Video recording and snapshot
- Built-in EMMC memory (16 GB)
- Supports distance measurement
- Adjustable color palettes
- Wi-Fi data transmission
- Waterproof, shockproof
- Powered by two standard CR123A or RCR123A rechargeable batteries
- Up to 4.5 hours continuous working
- External power supply capability
- Limited 3-year warranty

2 OPERATING INSTRUCTIONS

2.1. BASIC OPERATIONS

2.1.1 UNPACKING

The following steps must be completed prior to each mission.

1. Open the carrying case, remove the device, and verify that all components are included.
2. Inspect the device for any obvious evidence of damage to the optical surfaces, body, eyecup, operation buttons, etc. Ensure that all optical surfaces are clean and ready for use. Clean all optical surfaces with a lens tissue.

2.1.2 BATTERIES INSTALLATION

CAUTION:

Verify that the equipment is OFF before remove the batteries.

To install the batteries (refer to Figure 2-1):

1. Turn the battery cover knob (A) counterclockwise and then open the battery cover (B).
2. Install two CR123A or RCR123A batteries (C) into the battery compartment. Align the polarity symbols on the batteries as shown below.
3. Close the battery cover. Turn the battery cover knob clockwise until stop.

When the device is on a battery charge level is displayed on the status bar.

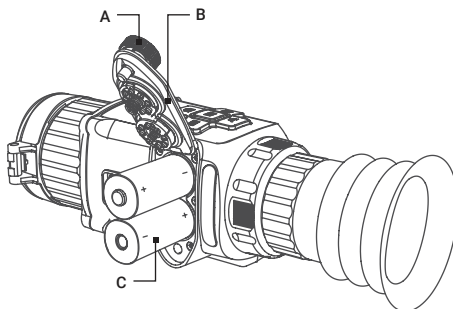





FIGURE 2-1. BATTERY INSTALLATION

2.1.3 SELECT BATTERY TYPE

You can change the battery type according to your need. Select the correct battery voltage in the device menu.

1. In the view mode, hold  button to show the menu.
2. Select  Battery Voltage menu item, and press  button to switch the voltage.

2.1.4 CONNECTING THE DEVICE

WARNING:

Please remove the batteries from the battery compartment before connecting the device to your PC, or it may cause computer damage.

1. Open the cable interface cover.
2. Connect the device and power adapter with a Type-C cable to power on the device. Alternatively, connect the device and PC to export files.

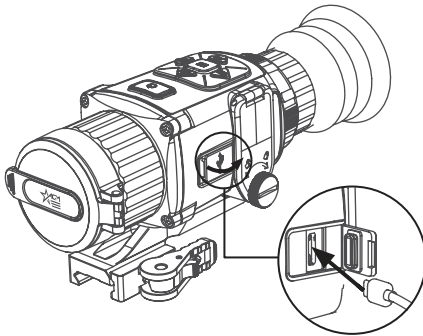

FIGURE 2-2. CABLE INTERFACE

2.1.5 CONTROL BUTTONS

The Rattler controls are shown in Figure 2-2 and are defined in Table 2-2.

Each button is responsible for some functions selected by short press or long press the button. Pushing a button for 3+ second is considered “long press/hold.”

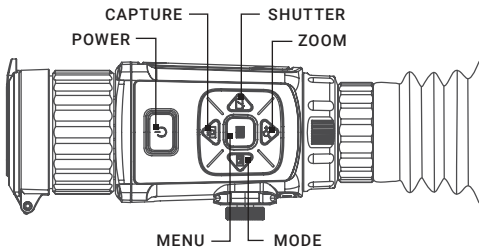









FIGURE 2-2. CONTROL BUTTONS

TABLE 2-2. BUTTON FUNCTIONS

BUTTON		FUNCTIONS
	POWER	Press: Sleep Mode/Wake Up Device Hold: Power On/Off
	MENU	Press: Enable/Disable OSD Hold: Menu Operation
	MODE	Press: Switch Palettes
	CAPTURE	Press: Capture Hold: Start/Stop Record Video
	SHUTTER	Press: Correct Non-uniformity of Display
	ZOOM	Press: Switch Digital Zoom Hold: Enable/Disable Reticule

2.1.6 POWER ON AND OFF

Power On

Hold the POWER button  for 4 seconds to power on the device. An image will appear on the display.

Refer to the figure below for the main view of the riflescope display.



FIGURE 2-3. THE DISPLAY MAIN VIEW

Power Off

When the device is turned on, hold  button for 4 seconds to power off the device.

In the “Auto Power Off” menu you can set the time for the automatic shutdown of the device as required (OFF / 30 min / 45 min).

2.1.7 SLEEP MODE

In the view mode, press the  button. After a few seconds, the display will turn off. Press the  button again to exit the Sleep Mode.

2.1.8 THERMAL VIEW OBSERVATION

1. Power on the riflescope.
2. Hold the riflescope and make sure the eyepiece covers your eye.
3. Adjust the diopter adjustment ring until the OSD text or image is clear.
4. Point the riflescope towards the target of the view. Bring the object into focus by rotate the objective focus ring.

NOTE:

You must perform the focus adjustment before any further use of the riflescope.

5. Set palette, brightness, contrast, scene mode and FFC (Flat Field Correction), to display the best image effect.

2.1.9 PALETTE SETTINGS

You can select different palettes to display the same scene in different effects. Press **M** button in the view mode to switch palettes.

TABLE 2-3. PALETTE SETTINGS

PALETTE	DESCRIPTION
WHITE HOT	The hot part is white-colored in view. The higher the temperature is, the lighter the color is.
BLACK HOT	The hot part is black-colored in view. The higher the temperature is, the more black the color is.
FUSION	The hot part is white-colored. From high temperature to low temperature, the image is colored in from white, yellow, red, pink to purple.
RED HOT	The hot part is red-colored in view. The higher the temperature is, the redder the color is.

2.1.10 DIGITAL ZOOM

Press **⊕** button in the view mode, the live view will switch between 1x, 2x, 4x and 8x digital zoom.

2.1.11 ON-SCREEN DISPLAY

Press **☰** button in the view mode to display or hide the OSD information.

When OSD (On-Screen Display) is on the information of Wi-Fi hotspot activation, digital zoom, storage memory status, and battery status displays in top right corner of viewfinder.

2.1.12 DISPLAY OF THE RETICLE

Hold **⊕** button in the view mode for 4 seconds, to display or hide the reticle. The crosshair helps you to aim at the target fast and accurately.

2.1.13 SHUTTER RELEASE

Press **ⓧ** button in the view mode to release the shutter once for correction of the non-uniformity of display.

2.1.14 RECORD/CAPTURE

Video Recording

Hold  button in the view mode and start recording. In the upper left corner, the recording time displays.

Hold  button again to stop recording.



FIGURE 2-4. VIDEO RECORDING

Snapshot Capturing

Press  button in the view mode, to capture picture.

NOTE:

- When capturing succeeds, the image freezes for 1 second and a prompt shows on the display.
- For exporting captured pictures, refer to File Export.

2.1.15 FILE EXPORT

WARNING:

Please remove the batteries from the battery compartment before connecting the device to your PC, or it may cause computer damage.

1. Before connecting the thermal rifle scope to a computer, please make sure that the Wi-Fi function of the rifle scope is disabled.
2. Connect the thermal rifle scope to your PC with USB cable and open the detected disk.
3. Enter DCIM>100EZVIZ to view the videos and snapshots.
 - Select and copy the videos to PC and play the file with the player.
 - Select and copy the snapshots to PC and view the files.
4. Disconnect the device from your PC.

NOTE:

- The device displays images when you connect it to PC. But functions such as recording, capturing and hot spot are disabled.
- When you connect the device to PC for the first time, it installs the drive program automatically.

2.1.16 INSTALLING THE RATTLER ON A PICATINNY/WEAVER RAIL

WARNING:

Always make sure your firearm is unloaded before you place the scope on the firearm. Reconfirm that the chamber is empty if you stop the procedure then resume later. Safe firearms handling rules should be followed at all times.

The Rattler comes fully-assembled with a Picatinny/Weaver mount. The mount is attached to the scope with two screws.

To install the Rattler on a Picatinny/ Weaver rail, perform the following (Figure 2-5) :

1. Unlock the clamping device of the scope mount by pushing down on the lever holder (A) and unlocking the lever (B).
2. Install the scope on the Picatinny/ Weaver rail so that the stop (C) slides into the transverse slot on the rail.
3. Affix the scope to the rail by locking the lever (B).
4. Verify that the clamping device is firmly holding the Rattler. If necessary, adjust the clamping device's lever-cam lock as detailed in part 2.1.17 (Clamping Device Adjustment).

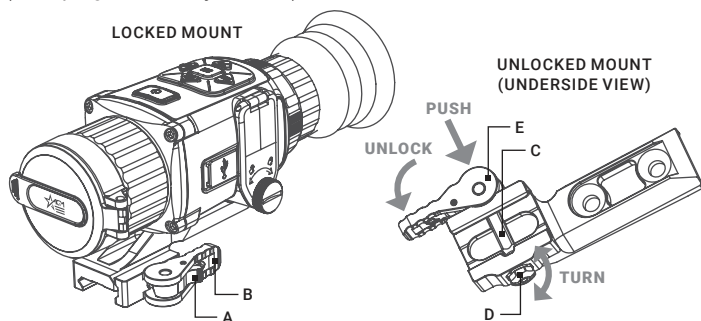

FIGURE 2-5. MOUNT

2.1.17 CLAMPING DEVICE ADJUSTMENT

To adjust the mount's clamping device, do the following:

1. Remove the Rattler from the weapon.
2. With the clamping device unlocked (as shown in Figure 2-5), push the cam (E) towards the arrow, which will cause the nut (D) to slide out of its hole.
3. To tighten/ loosen the clamping device, push down on the cam (E) and turn the nut (D) CW/ CCW respectively, in one-two increments (see note below). Much like when the cam (E) is released, backward-moving spring will cause the nut (D) to slide back into its hole.

NOTE:



The eight-sided nut of the mount lever-cam lock will only fit into their hole if turned in one of the discrete positions, using increments equal to $360^\circ/8$.

4. Verify that the adjusted lever-cam lock securely holds the weapon mounting rail.

2.2 MAIN FUNCTIONS

2.2.1 MENU OPERATION

When the device powers on, hold  button in the view mode for 4 seconds to display the menu.

Press  and  buttons to move between menu items. The active element is highlighted in orange. Press  button to select menu item or change an option.

Hold  button to save settings and exit the menu.

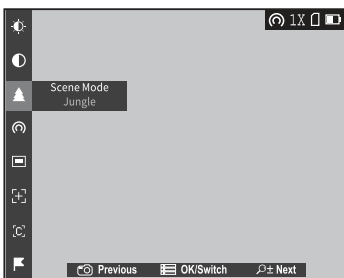























FIGURE 2-6. MAIN MENU



TABLE 2-4. MENU FUNCTION

MENU ITEM	SYMBOL	OPTION	FUNCTION
BATTERY VOLTAGE		3.0 V / 3.7 V	Select the battery voltage.
BRIGHTNESS		5 Levels of brightness	Adjust the image brightness.
CONTRAST		5 Levels of contrast	Adjust the image contrast.
SCENE MODE		Recognition	Switch between the Recognition mode and Jungle mode.
		Jungle	
NETWORK		OFF	Enable or disable the Wi-Fi hotspot.
		Hotspot	
PIP		Upper Left/ Upper Middle/ Upper Right/ Close	Enable or disable the PIP function. Set the position of the PIP window.
BORESIGHTING		5 Types of reticle	Select the reticle type. Set the center of the reticle.
COLOR		White/ Green/ Red	Select the reticle color.



MENU ITEM	SYMBOL	OPTION	FUNCTION
TRAJECTORY		5 Profiles	One shot zero correction.
FFC		Auto / Manual / External	Select the FFC mode.
MEASURE		0.8m/1.2m/ 1.8m/3.0m Target Height	Enter distance measurement mode.
HOT TRACKING		OFF	Enable/disable hot spot mark (marking the spot of highest temperature).
		ON	
DPC		---	Correct dead pixel manually.
CVBS		OFF	Turn on and off the CVBS Output function.
		ON	
LANGUAGE		17 Languages	Select the language of interface.
VERSION		---	View the firmware version number and serial number.
RESTORE		---	Restore the device to defaults.
AUTO POWER OFF		OFF/30 min/ 45 min	Set the automatic shutdown time.

2.2.2 BATTERY TYPE

You can change the battery type according to your need. Select the correct battery voltage in the device menu.

1. Hold  button in the view mode to show the menu.
2. Select  Battery Voltage menu item, and press  button to switch the battery voltage.



2.2.3 BRIGHTNESS ADJUSTMENT

1. Hold  button to show the menu.
2. Select  Brightness menu item and press  button to adjust the brightness.

In White Hot mode, you can select one of five levels of the brightness to adjust the image lighter or darker.









In Black Hot mode, the brightness of the image turns in the opposite way.

2.2.4 CONTRAST ADJUSTMENT

1. Hold  button to go to the menu.
2. Select  Contrast menu item and press  button to adjust the image contrast. You can select one of five levels of the contrast.



2.2.5 SCENE MODE

You can select proper Scene Mode according to environment temperature to improve the display effect.

1. Hold  button to show the menu.
2. Select  /  Scene Mode menu item ( is default option) and press  button to switch scene.
 - Recognition mode () improves an image so that the object edge is more distinct.
 - Jungle mode () is more suitable for hunting environment because of the highlight function of small objects.
3. Hold  for 4 seconds to save settings and exit.

2.2.6 NETWORK CONFIGURATION



Connect your phone to the Wi-Fi hotspot of the riflescope, you can configure the parameters and realize functions of the device.

1. Hold  button to show the menu.
2. Select  menu item to enable Wi-Fi hotspot function.
3. Turn on the WLAN and connect to the Wi-Fi hotspot.
 - Hotspot Name: Wlan-IPTS Serial No.
 - Hotspot Password: Last 9 digits of Serial No.
4. Search the client software on App Store (iOS System) or Google Play™ (Android System) to download and install the app. T-Vision APP is recommend.
5. Open the APP and connect your phone with the device. You can view the interface of riflescope on your phone.

NOTE:

When the power is less than 15%, the Wi-Fi hotspot function will be turned off automatically.

2.2.7 PICTURE IN PICTURE MODE

1. Hold  button to show the menu.
2. Select  PIP menu item and enter PIP mode. The details show in the upper left corner.

NOTE:

When Reticle is enabled, the PIP view is the detail of crosshair.
When Reticle is not enabled, the PIP view is the detail of central part.

3. Press  button to switch the PIP type. Upper Left, Upper Middle, Upper Right, and OFF are selectable.

NOTE:

When you select Upper Right as PIP type, the OSD will be blocked.

4. Hold  button to exit.

If digital zoom is enabled, the PIP view also zooms. If the digital zoom ratio exceeds 4, the PIP does not zoom.

2.2.8 BORESIGHTING

Enable the reticle to aim at the target. Hold  button in the view mode for 4 seconds, to display or hide the reticle.





1. Hold  button to show the menu.
2. Select  Boresighting menu item. A reticle shows in the center of the view.
3. Press  or  buttons to select one of 5 reticle type. Then press  button to confirm.



FIGURE 2-7. RETICLE PATTERNS

NOTE:

The scale intervals of the Reticle 5 changes synchronously under the current digital zoom.

You can boresight the scope by moving the reticle on screen:





1. In Boresighting menu press , ,  and  buttons to move the reticle position. The coordinate shows the current position of the reticle.
2. Hold  button to save and exit.



FIGURE 2-8. BORESIGHT CORRECTION





TABLE 2-5. BORESIGHT CORRECTIONS

MODEL	ADJUSTMENT VALUE	RETICLE OFFSET	BORESIGHT INCREMENT
RATTLER TS25	1 click	1 pixel	0.27 mil / 0.91 MOA / 2.65 cm on 100m distance / 1 in on 100 yd distance
RATTLER TS35	1 click	1 pixel	0.37 mil / 1.28 MOA / 3.73 cm on 100m distance / 1.3 in on 100 yd distance

2.2.9 RETICLE COLOR

You can change the color of the reticle.



Enable reticle first.

1. Hold  button to show the menu.
2. Select  Color menu item and press  button to switch the color of reticle. White, Green, and Red colors are selectable.
3. Hold  button to save and exit.

2.2.10 TRAJECTORY CORRECTION

Enable the trajectory correction to shot the target with high accuracy by marking the offset between the big crosshair and small crosshair.

Trajectory correction available only with Reticle 1 type. Select Reticle 1 in the Boresighting menu.

1. Hold  button to show the menu.
2. Select  Trajectory menu item. Two crosshairs show in the view. The big one is reticle crosshair, and the small one is trajectory correction crosshair.

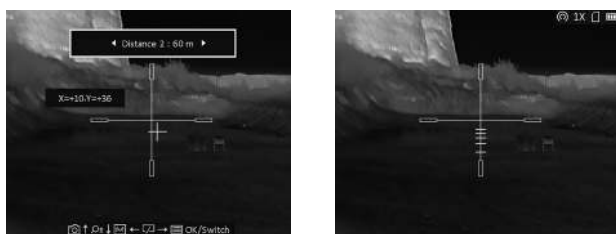









FIGURE 2-9. TRAJECTORY CORRECTION

3. Set the distance.
 - 1) Press  button, and then press  or  buttons to adjust the distance between the target and the device.
 - 2) Press  button to save the distance settings.
4. Set the crosshair position of trajectory correction.
 - 1) Aim the big crosshair at the target.
 - 2) Shot and mark the actual drop point of the bullet.

3) Press , ,  and  buttons to move the small cursor to the position of the actual drop point. You can view the coordinate of the cursor in the view.

5. Press  button to switch to the next distance.

6. Repeat step 3 to 4 to set another trajectory correction position.

You can save up to five corrections for different distances. Corrective aiming points will be displayed with short lines on the reticle.

7. Hold  button to exit.

NOTE:

The scale of the Reticle 1 with trajectory correction marks changes synchronously under the digital zoom.

2.2.11 FLAT FIELD CORRECTION

Flat Field Correction (FFC) function can correct non-uniformity of display.

1. Hold  button to show the menu.

2. Select  FFC menu item and press  button to switch the FFC mode.

Auto: The riflescope performs FFC automatically when switching on or rebooting the camera.

Manual: Hold  button in live view to correct the non-uniformity of display.

External: Cover the lens cap, then hold  button in live view to correct the non-uniformity of display.

3. Hold  button to confirm the setting and exit.



2.2.12 DISTANCE MEASUREMENT

The device can detect the distance between the target and the observation position.



NOTE:

When measuring the distance, keep the hand and the position steady. Otherwise, the accuracy may be affected.

1. Hold  button to show the menu.

2. Select  menu item and press  button to enter the Distance Measurement mode.

3. Press  button to go to the target setting interface.

1) Press  or  to select the target from Wolf (0.8m), Bear (3.0m), Deer (1.2m), and Custom (1.8m). Each target preset can be modified from 0.1 to 9.9m.

2) Set the target and press  button to confirm.

4. Align the center of top mark with the edge of target top. Press  button.

The cursor blinks on the top edge of the target.

5. Align the center of bottom mark with the edge of target bottom. Press .

The left top of the image displays the distance measurement result and the height of the target.



FIGURE 2-10. DISTANCE MEASUREMENT

NOTE:

Go to distance measurement interface, and press button to view the result of the previous measuring target.

2.2.13 HOT TRACKING

The device can detect the highest temperature spot in the scene and mark it on display.

1. Hold button to show the menu.
2. Select / and press button to enable/disable hot spot mark (marking the spot of highest temperature).

When the hot spot mark is enabled, the mark displays in the spot of the highest temperature. When the scene changes, the mark moves.

2.2.14 DEFECTIVE PIXELS CORRECTION

Defective Pixels Correction (DPC) function can correct the defective pixels on the screen which are not performed as expected.

Before you start switch the palette to White Hot mode.

1. Hold button to show the menu.
2. Select DPC menu item and press button.
3. Press , , and buttons to move the cursor to the position of dead pixel.
6. Hold button to correct the dead pixel.

2.2.15 CVBS OUTPUT

You can view the video on CVBS monitor, to get a better and clear image, more convenient to check the detail.

1. Connect the USB-CVBS cable to USB port of thermal rifle scope and to monitor's CVBS port.

NOTE:

USB-CVBS cable need to be purchase separately.





NOTE:

CVBS Output function doesn't support hot plug, so please connect the cable before power on.

2. Hold button to show the menu.
3. Select **CVBS** menu item and press button to turn on or turn off the CVBS video output.

2.2.16 LANGUAGE SETTING

You can select different languages of user interface.



1. Hold  button to show the menu.
2. Select  Language menu item and press  button to select the language. The following languages are supported: English, Russian, German, Czech, French, Spanish, Danish, Norwegian, Swedish, Finnish, Hungarian, Italian, Polish, Portuguese, Romanian, Slovak, Spanish.
3. Hold  button to save settings and exit.

2.3 CLIENT SOFTWARE INTRODUCTION

We recommend using T-Vision (V5.4.12 and below) software. Install the client software on your mobile phone first, and then connect your phone to the hotspot of the riflescope. Refer to chapter 2.2.6 for details of hotspot connection.

NOTE:

The device password is set by user at first activation. If the password was lost or forgotten, it can be reset. To make a reset, provide the following action:

1. When the riflescope is turned on, hold  button to activate the OSD menu.
2. Select  menu item and press  button to restore all parameters to default settings.

1. Open the APP and connect the phone or pad with the device.
2. If the device is inactivated, set the password and activate it. If the device is activated, enter the password to add it to app.
3. When the device is added, the live view can be seen. You can view the interface of the riflescope on the software. User can change such image parameters as brightness, contrast, zoom, palettes directly via phone or pad as well as record video on phone/pad memory.

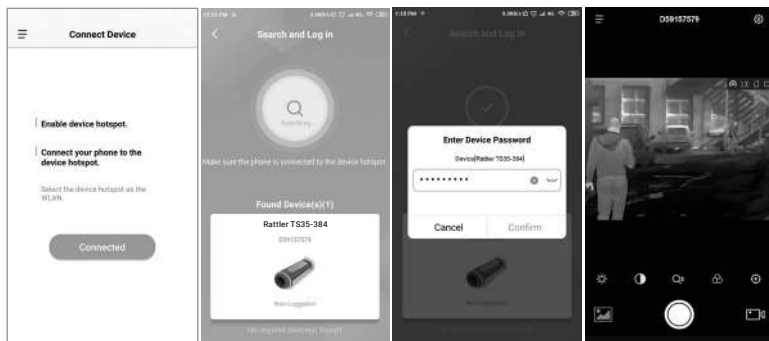

FIGURE 2-11. CLIENT SOFTWARE

3 MAINTENANCE

3.1 MAINTENANCE

3.1.1 CLEANING PROCEDURES

1. Gently brush off any dirt from the body of the device using a clean, soft cloth.
2. Moisten the cloth with fresh water and gently wipe down the external surfaces (except lenses).
3. Dry any wet surfaces (except lenses) using another dry, clean, soft cloth.
4. Using a lens brush, carefully remove all loose dirt from the lenses.
5. Dampen a cotton swab with ethanol and slowly, gently wipe down the lenses. Clean the glass surfaces using circular movements, starting from the center of the lens and moving out towards the edge, without touching the lens holder. Change the cotton swab after each circular stroke. Repeat this step until the glass surfaces are clean.
6. Clean the accessories with a soft brush (or cloth) dampened with soap and water.

3.1.2 PREPARING FOR EXTENDED STORAGE



CAUTION:

Thoroughly dry each item before placing them into the storage case.

To prepare the riflescope for extended storage:

1. Clean the riflescope and accessories.
2. Place all items into the storage case.

3.1.3 VIEW DEVICE INFORMATION

1. Hold  button to show the menu of device.
2. Select  Version menu item and press  button. You can view the device information such as firmware version, and serial number.

3.1.4 UPGRADE DEVICE

WARNING:

Please remove the batteries from the battery compartment before connecting the device to your PC, or it may cause computer damage.



If you removed the batteries, please make sure the device is connected to the computer during the update process. Otherwise, the device will shut off and may cause unnecessary upgrade failure, firmware damage, etc.

1. Download the upgrade package to your PC and unzip it. (Do not open the DAV or BIN file on your computer as it may corrupt the file.)
2. Connect the thermal device to your PC with USB cable.
3. Turn on the thermal device.

4. Disable the Wi-Fi Hotspot function in the device menu if WiFi is enabled.
5. Open the detected disk (USB drive) in file manager program. Copy the unzipped .dav file and paste it to the root directory of the device.
6. Turn off the device.
7. Turn on the device. After a while, the firmware update process will start automatically. During the update, the screen will display the inscription "Upgrading ...". The update process will be completed when the inscription "Upgrading ..." goes out.

Repeat steps 5-7 for each updating file.

3.1.5 RESTORE DEVICE

1. Hold  button to show the menu of device.
2. Select  Restore menu item and press  button to restore the device to defaults according to the prompt.

3.2 TROUBLESHOOTING

Table 3-1 lists the most common malfunctions that may occur with your equipment. Perform the tests, inspections, and corrective actions in the order they appear in the table.

This table does not list all the malfunctions that may occur with your device, or all of the tests, inspections, and corrective actions that may be necessary to fix them. If the equipment malfunction is not corrected by the suggested actions, or a problem occurs that is not listed in this table, please contact AGM Global Vision's Customer Support center or your retailer.

TABLE 3-1. TROUBLESHOOTING

MALFUNCTION	CORRECTIVE ACTION
The charge indicator flashes improperly.	Examine whether the device is charged with standard power adapter and the charging temperature is 0°C to 45°C (32°F to 113°F).
Device power indicator is off.	Examine whether the device is off-battery.
The image of the riflescope is not clear.	Perform the sight adjustment referring to section 2.1.
Wi-Fi is not found.	Examine whether the Wi-Fi function is turned on. If not, go to OSD menu and turn on Wi-Fi.
Capturing or recording fails.	Examine the items below: 1. Whether the device is connected to your PC and disabled the capturing and recording. 2. Whether the storage space is full. 3. Whether the device is low-battery.
The PC cannot identify the riflescope.	Examine the items below: 1. Whether the device is connected to your PC with standard USB cable. 2. If you use other USB cables, make sure the cable length is no longer than 1 m. 3. Whether the Wi-Fi function is turned on. If so, go to OSD menu and turn off Wi-Fi.

4 WARRANTY INFORMATION

4.1 WARRANTY INFORMATION AND REGISTRATION

4.1.1 WARRANTY INFORMATION

This product is guaranteed to be free from manufacturing defects in material and workmanship under normal use for a period of three (3) years from the date of purchase. In the event that a defect covered by the warranty below occurs during the applicable period stated above, AGM Global Vision, at its discretion, will either repair or replace the product; such action on the part of AGM Global Vision shall be the full extent of AGM Global Vision's liability, and the Customer's sole and exclusive repairation. This warranty does not cover a product if it has been (a) used in ways other than its normal and customary manner; (b) subjected to misuse; (c) subjected to alterations, modifications or repairs by the Customer or by any party other than AGM Global Vision without prior written consent of AGM Global Vision; (d) is the result of a special order or categorized as "close-out" merchandise or merchandise sold "as-is" by either AGM Global Vision or the AGM Global Vision dealer; or (e) merchandise that has been discontinued by the manufacturer and either parts or replacement units are not available due to reasons beyond the control of AGM Global Vision. AGM Global Vision shall not be responsible for any defects or damage that in AGM Global Vision's view are a result from the mishandling, abuse, misuse, improper storage or improper operation of the device, including use in conjunction with equipment that is electrically or mechanically incompatible with, or of inferior quality to, the product, as well as failure to maintain the environmental conditions specified by the manufacturer. This warranty is extended only to the original purchaser. Any breach of this warranty shall be enforced unless the customer notifies AGM Global Vision at the address noted below within the applicable warranty period.

The customer understands and agrees that except for the foregoing warranty, no other warranties written or oral, statutory, expressed or implied, including any implied warranty of merchantability or fitness for a particular purpose, shall apply to the product. All such implied warranties are hereby and expressly disclaimed.

4.1.2 LIMITATION OF LIABILITY

AGM Global Vision will not be liable for any claims, actions, suits, proceedings, costs, expenses, damages, or liabilities arising out of the use of this product. Operation and use of the product are the sole responsibility of the Customer. AGM Global Vision's sole undertaking is limited to providing the products and services outlined herein in accordance with the terms and conditions of this Agreement. The provision of products sold and services performed by AGM Global Vision to the Customer shall not be interpreted, construed, or regarded, either expressly or implied, as being for the benefit of or creating any obligation toward any third party of legal entity outside AGM Global Vision and the Customer; AGM Global Vision's obligations under this Agreement extend solely to the Customer. AGM Global Vision's liability hereunder for damages,

regardless of the form or action, shall not exceed the fees or other charges paid to AGM Global Vision by the customer or customer's dealer. AGM Global Vision shall not, in any event, be liable for special, indirect, incidental, or consequential damages, including, but not limited to, lost income, lost revenue, or lost profit, whether such damages were foreseeable or not at the time of purchase, and whether or not such damages arise out of a breach of warranty, a breach of agreement, negligence, strict liability, or any other theory of liability.

4.1.3 PRODUCT REGISTRATION

In order to validate the warranty on your product, the customer must complete and submit AGM Global Vision PRODUCT REGISTRATION FORM on our website (www.agmglobalvision.com/customer-support).

4.1.4 OBTAINING WARRANTY SERVICE

To obtain warranty service on your unit, the End-user (Customer) must notify the AGM Global Vision service department via e-mail. Send any requests to support@agmglobalvision.com to receive a Return Merchandise Authorization number (RMA). When returning any device, please take the product to your retailer, or send the product, postage paid and with a copy of your sales receipt, to AGM Global Vision's service center at the address listed above. All merchandise must be fully insured with the correct postage; AGM Global Vision will not be responsible for improper postage or merchandise that becomes lost or damaged during shipment. When sending product back, please clearly write the RMA# on the outside of the shipping box. Please include a letter that indicates your RMA#, the Customer's Name, a Return Address, reason for the return, contact information (valid telephone numbers and/or an e-mail address), and proof of purchase that will help us to establish the valid start date of the warranty. Product merchandise returns that do not have an RMA# listed may be refused, or a significant delay in processing may occur. Estimated Warranty service time is 10-20 business days. The End-user/Customer is responsible for postage to AGM Global Vision for warranty service. AGM Global Vision will cover return postage/shipping after warranty repair to the End-user/Customer only if the product is covered by the aforementioned warranty. AGM Global Vision will return the product after warranty service by domestic UPS Ground service and/or domestic mail. Should any other requested, required, or international shipping methods be necessary, the postage/shipping fee will be the responsibility of the End-user/Customer.

For service, repair or replacement, please contact:

AGM Global Vision, LLC

173 West Main Street

PO Box 962

Springerville, AZ 85938

Tel. 928.333.4300

support@agmglobalvision.com

www.agmglobalvision.com

5 SPECIFICATIONS

5.1 SPECIFICATIONS

	RATTLER TS25-384	RATTLER TS35-384
Detector Type	17 μ m VOx Uncooled Focal Plane Arrays	
Resolution	384x288	
Refresh Rate	50 Hz	
Response Waveband	8 μ m to 14 μ m	
Lens (Focal Length)	25 mm	35 mm
Aperture	F1.0	F1.0
Field of View (HxV)	14.9° x 11.2°	10.0° x 8.0°
Magnification	1.5x	2.14x
Digital Zoom	1x, 2x, 4x, 8x	1x, 2x, 4x, 8x
Observation Distance	Up to 882m	Up to 1235 m
Eye Relief	45 mm	
Monitor	1024x768, 0.39 inch, OLED	
FFC (Flat Field Correction)	Auto, Manual, External Correction	
Palettes	Black Hot, White Hot, Red Hot, Fusion	
Highest Temperature Spot Tracking	Yes	
Scene Mode	Jungle, Recognition	
Reticle	5 types, 3 colors, on/off	
Distance Measurement	Yes (Stadiometric Rangefinder)	
Boresight Adjustment	Digital Controlled	
Boresight Increment	0.27 mil / 0.91 MOA	0.37 mil / 1.28 MOA
Wi-Fi Hotspot	Yes	
Sleep Mode	Yes	
Picture In Picture Mode	Yes	
Built-in Storage	16 GB EMMC	
Record Video	On-board video recording	
Capture Snapshot	Yes	
CVBS Output	Yes (via USB)	
Battery Type	Two CR123A or RCR123A Lithium	
Battery Operating Time	Up to 4.5 hours continuous running (@25°C, WiFi off)	
Battery Capacity Display	Yes	
Power	5 VDC/2 A, USB Type-C interface	
Working Temperature	-20°C to 55°C (-4°F to 131°F)	
Protection Level	IP67	
Drop Test Height	1.5 m (4.9 feet)	
Dimension (with mount)	226 x 62 x 82 mm (8.9 x 2.4 x 3.2 in)	
Weight (w/o batteries)	502 g (1.1 lb)	511 g (1.13 lb)

All data subject to change without notice.



AGM Global Vision, LLC

MAIN OFFICE

173 West Main Street

PO Box 962

Springerville, AZ 85938

USA

Tel. +1.928.333.4300

info@agmglobalvision.com

www.agmglobalvision.com

EUROPEAN OFFICE

Andrey Lyapchev #7

Sofia, P.C. 1756

Bulgaria

Tel. +35.988.412.5573

info@agmglobalvision.eu

www.agmglobalvision.eu